

Dual IGBTMOD™ U-Series Module 150 Amperes/600 Volts

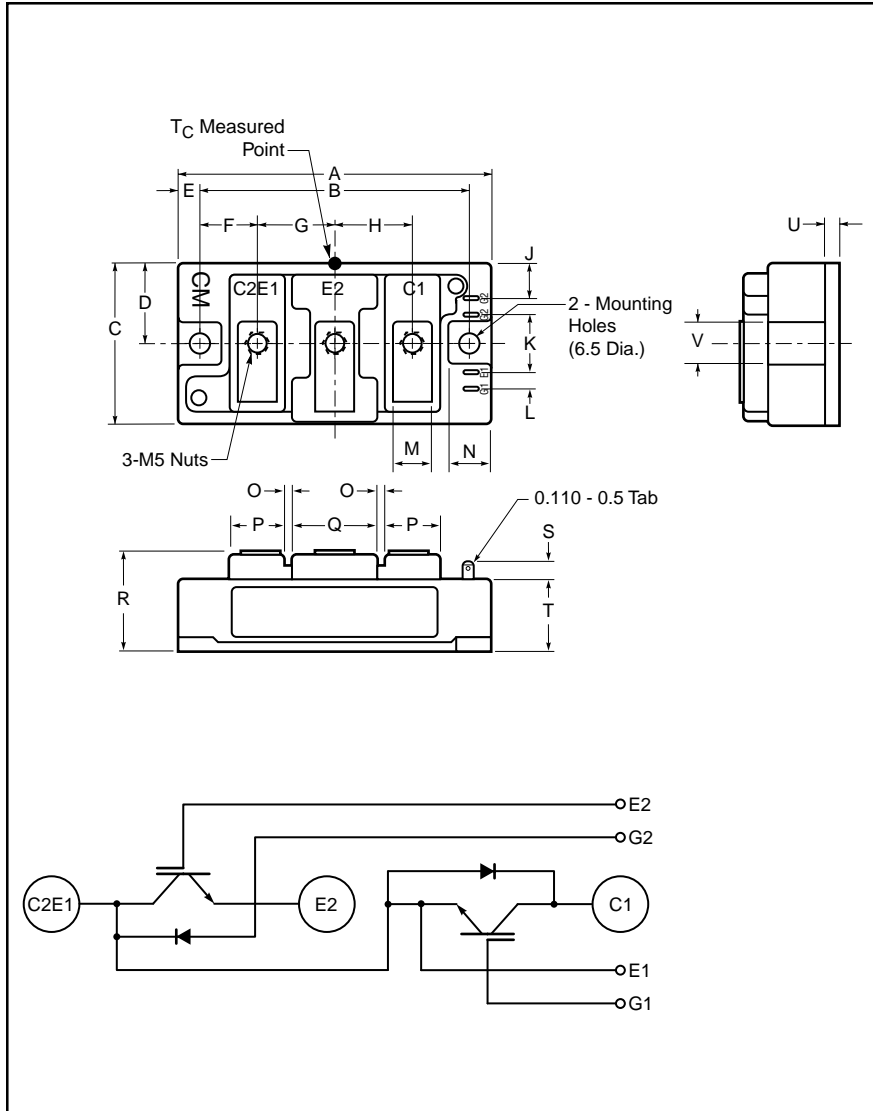

Outline Drawing and Circuit Diagram

| Dimensions | Inches | Millimeters |
|------------|-----------|-------------|
| A | 3.7 | 94.0 |
| B | 3.15±0.01 | 80.0±0.25 |
| C | 1.89 | 48.0 |
| D | 0.94 | 24.0 |
| E | 0.28 | 7.0 |
| F | 0.67 | 17.0 |
| G | 0.91 | 23.0 |
| H | 0.91 | 23.0 |
| J | 0.43 | 11.0 |
| K | 0.71 | 18.0 |
| L | 0.16 | 4.0 |

| Dimensions | Inches | Millimeters |
|------------|------------------|----------------|
| M | 0.47 | 12.0 |
| N | 0.53 | 13.5 |
| O | 0.1 | 2.5 |
| P | 0.63 | 16.0 |
| Q | 0.98 | 25.0 |
| R | 1.18 +0.04/-0.02 | 30.0 +1.0/-0.5 |
| S | 0.3 | 7.5 |
| T | 0.83 | 21.2 |
| U | 0.16 | 4.0 |
| V | 0.51 | 13.0 |



Description:

Powerex IGBTMOD™ Modules are designed for use in switching applications. Each module consists of two IGBT Transistors in a half-bridge configuration with each transistor having a reverse-connected super-fast recovery free-wheel diode. All components and interconnects are isolated from the heat sinking baseplate, offering simplified system assembly and thermal management.

Features:

- Low Drive Power
- Low $V_{CE(sat)}$
- Discrete Super-Fast Recovery Free-Wheel Diode
- Isolated Baseplate for Easy Heat Sinking

Applications:

- AC Motor Control
- Motion/Servo Control
- UPS
- Welding Power Supplies
- Laser Power Supplies

Ordering Information:

Example: Select the complete module number you desire from the table - i.e. CM150DU-12H is a 600V (V_{CES}), 150 Ampere Dual IGBTMOD™ Power Module.

| Type | Current Rating Amperes | V_{CES} Volts (x 50) |
|------|------------------------|------------------------|
| CM | 150 | 12 |

CM150DU-12H
Dual IGBTMOD™ U-Series Module
 150 Amperes/600 Volts

Absolute Maximum Ratings, $T_j = 25\text{ }^\circ\text{C}$ unless otherwise specified

| Ratings | Symbol | CM150DU-12H | Units |
|---|-----------|-------------|------------------|
| Junction Temperature | T_j | -40 to 150 | $^\circ\text{C}$ |
| Storage Temperature | T_{stg} | -40 to 125 | $^\circ\text{C}$ |
| Collector-Emitter Voltage (G-E SHORT) | V_{CES} | 600 | Volts |
| Gate-Emitter Voltage (C-E SHORT) | V_{GES} | ± 20 | Volts |
| Collector Current ($T_c = 25^\circ\text{C}$) | I_C | 150 | Amperes |
| Peak Collector Current | I_{CM} | 300* | Amperes |
| Emitter Current** ($T_c = 25^\circ\text{C}$) | I_E | 150 | Amperes |
| Peak Emitter Current** | I_{EM} | 300* | Amperes |
| Maximum Collector Dissipation ($T_c = 25^\circ\text{C}$, $T_j \leq 150^\circ\text{C}$) | P_C | 600 | Watts |
| Mounting Torque, M5 Main Terminal | – | 31 | in-lb |
| Mounting Torque, M6 Mounting | – | 40 | in-lb |
| Weight | – | 310 | Grams |
| Isolation Voltage (Main Terminal to Baseplate, AC 1 min.) | V_{ISO} | 2500 | Volts |

* Pulse width and repetition rate should be such that the device junction temperature (T_j) does not exceed $T_{j(max)}$ rating.

**Represents characteristics of the anti-parallel, emitter-to-collector free-wheel diode (FWDi).

Static Electrical Characteristics, $T_j = 25\text{ }^\circ\text{C}$ unless otherwise specified

| Characteristics | Symbol | Test Conditions | Min. | Typ. | Max. | Units |
|--------------------------------------|---------------|---|------|------|------|---------------|
| Collector-Cutoff Current | I_{CES} | $V_{CE} = V_{CES}$, $V_{GE} = 0V$ | – | – | 1 | mA |
| Gate Leakage Voltage | I_{GES} | $V_{GE} = V_{GES}$, $V_{CE} = 0V$ | – | – | 0.5 | μA |
| Gate-Emitter Threshold Voltage | $V_{GE(th)}$ | $I_C = 15\text{mA}$, $V_{CE} = 10V$ | 4.5 | 6 | 7.5 | Volts |
| Collector-Emitter Saturation Voltage | $V_{CE(sat)}$ | $I_C = 150A$, $V_{GE} = 15V$, $T_j = 25^\circ\text{C}$ | – | 2.4 | 3.0 | Volts |
| | | $I_C = 150A$, $V_{GE} = 15V$, $T_j = 125^\circ\text{C}$ | – | 2.6 | – | Volts |
| Total Gate Charge | Q_G | $V_{CC} = 300V$, $I_C = 150A$, $V_{GE} = 15V$ | – | 300 | – | nC |
| Emitter-Collector Voltage** | V_{EC} | $I_E = 150A$, $V_{GE} = 0V$ | – | – | 2.6 | Volts |

**Represents characteristics of the anti-parallel, emitter-to-collector free-wheel diode (FWDi).

Dynamic Electrical Characteristics, $T_j = 25\text{ }^\circ\text{C}$ unless otherwise specified

| Characteristics | Symbol | Test Conditions | Min. | Typ. | Max. | Units | |
|---------------------------------|---------------------|--|----------------------------------|------|------|---------------|----|
| Input Capacitance | C_{ies} | | – | – | 13.2 | nf | |
| Output Capacitance | C_{oes} | $V_{CE} = 10V$, $V_{GE} = 0V$ | – | – | 7.2 | nf | |
| Reverse Transfer Capacitance | C_{res} | | – | – | 2 | nf | |
| Resistive | Turn-on Delay Time | $t_{d(on)}$ | $V_{CC} = 300V$, $I_C = 150A$, | – | – | 100 | ns |
| Load | Rise Time | t_r | $V_{GE1} = V_{GE2} = 15V$, | – | – | 350 | ns |
| Switch | Turn-off Delay Time | $t_{d(off)}$ | $R_G = 4.2\Omega$, Resistive | – | – | 300 | ns |
| Times | Fall Time | t_f | Load Switching Operation | – | – | 300 | ns |
| Diode Reverse Recovery Time** | t_{rr} | $I_E = 150A$, $di_E/dt = -300A/\mu\text{s}$ | – | – | 160 | ns | |
| Diode Reverse Recovery Charge** | Q_{rr} | $I_E = 150A$, $di_E/dt = -300A/\mu\text{s}$ | – | 0.36 | – | μC | |

**Represents characteristics of the anti-parallel, emitter-to-collector free-wheel diode (FWDi).

Thermal and Mechanical Characteristics, $T_j = 25\text{ }^\circ\text{C}$ unless otherwise specified

| Characteristics | Symbol | Test Conditions | Min. | Typ. | Max. | Units |
|--------------------------------------|----------------|------------------------------------|------|-------|------|--------------------|
| Thermal Resistance, Junction to Case | $R_{th(j-c)Q}$ | Per IGBT 1/2 Module | – | – | 0.21 | $^\circ\text{C/W}$ |
| Thermal Resistance, Junction to Case | $R_{th(j-c)D}$ | Per FWDi 1/2 Module | – | – | 0.47 | $^\circ\text{C/W}$ |
| Contact Thermal Resistance | $R_{th(c-f)}$ | Per Module, Thermal Grease Applied | – | 0.035 | – | $^\circ\text{C/W}$ |

CM150DU-12H
Dual IGBTMOD™ U-Series Module
 150 Amperes/600 Volts

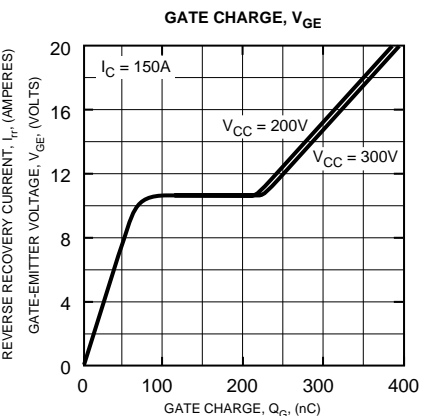
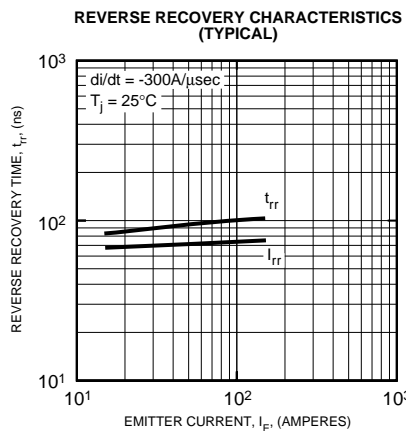
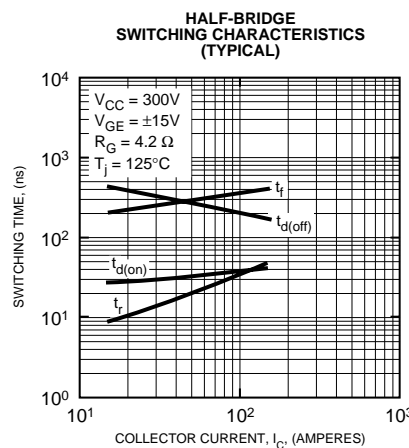
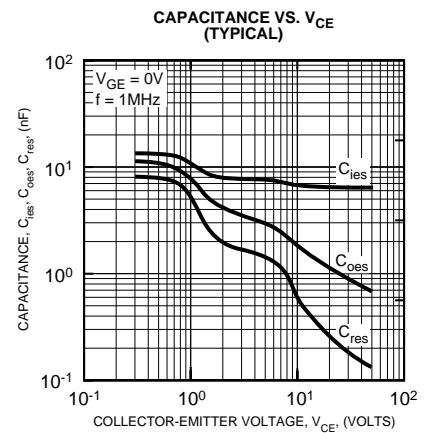
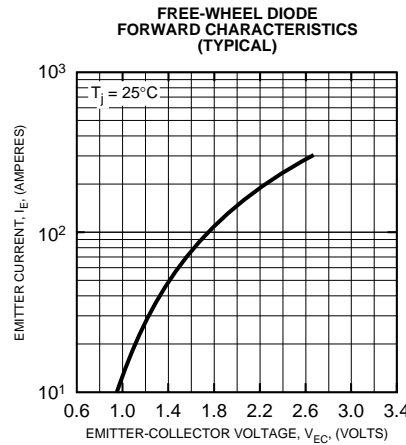
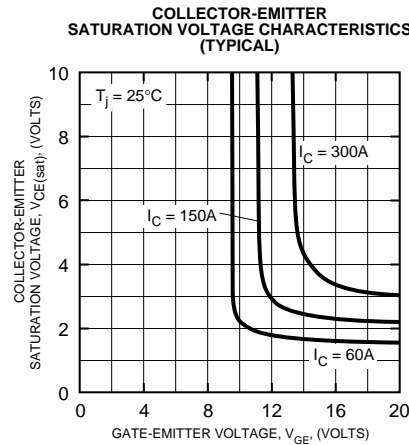
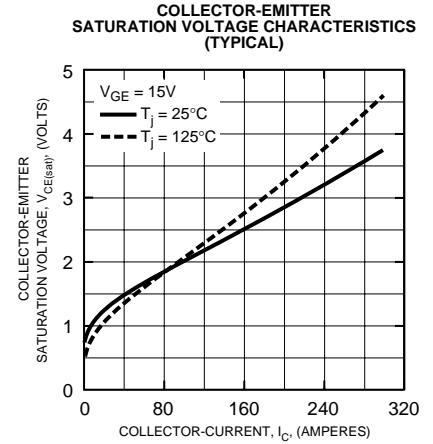
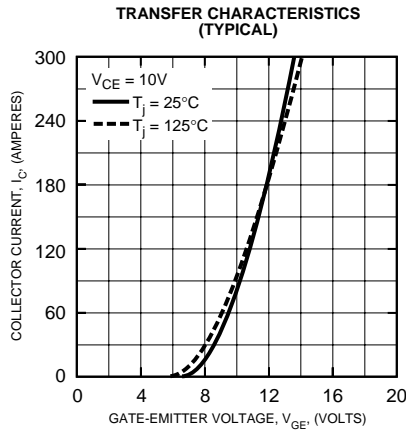
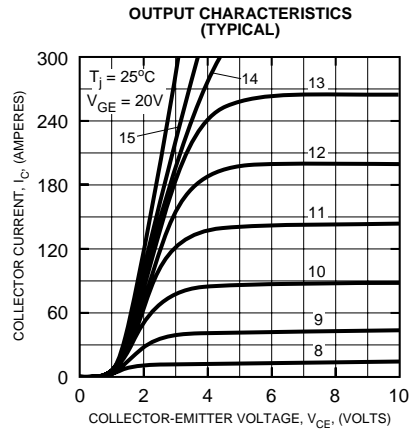

CM150DU-12H
Dual IGBTMOD™ U-Series Module
 150 Amperes/600 Volts

